

e 845



Instruction manual

evolution
Stage Microphones

SENNHEISER
The Pursuit of Perfect Sound

A

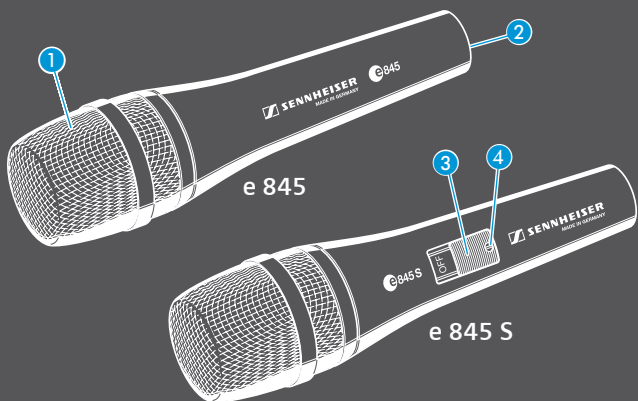

B



C

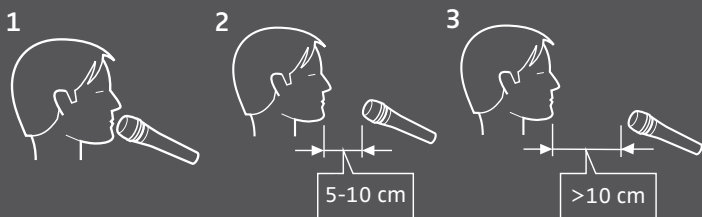

D

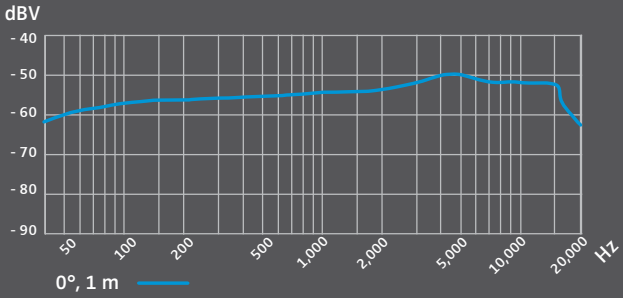
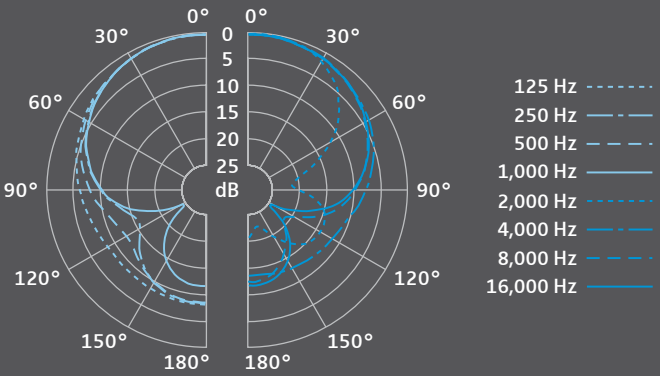

Important safety information

- Please read this instruction manual carefully and completely before using the product.
- Make this instruction manual easily accessible to all users at all times.
- Always include this instruction manual when passing the product on to third parties.

Before operation

- Never open the housing of the product. If products are opened by customers in breach of this instruction, the warranty becomes null and void.
- Only use attachments, accessories or spare parts specified by Sennheiser.

During operation

- Liquids entering the product can short-circuit the electronics or damage the mechanics. Keep all liquids away from the product.
- Solvents or cleansing agents can damage the surface of the product. Only use a soft, slightly damp cloth to clean the product.
- Do not expose the product to extreme temperatures.

After operation

- Handle the product with care and store it in a clean, dust-free environment.

Intended use

Intended use includes:

- having read this instruction manual, especially the chapter "Important safety information",
- using the product within the operating conditions and limitations described in this instruction manual.

"Improper use" means using the product other than as described in this instruction manual, or under operating conditions which differ from those described herein.

The e 845

The e 845 is a high-performance lead vocal microphone, specially designed for rough stage use. Due to its extended high-frequency response and super-cardioid pick-up pattern, the e 845 ensures vocal projection through high on-stage sound levels.

The microphone has a smooth, warm tonal response and full dynamic range. The presence boost ensures vocal clarity and projection.

The balanced frequency response maintains signal quality when moving on and off axis during performance. The minimal proximity effect provides for consistently clear bass-end performance when singing closer to, or further from the microphone, providing greater on-stage freedom.

The super-cardioid pick-up pattern provides excellent feedback rejection. The rugged metal construction and internal damping isolates handling noise.

The e 845 S variant features a silent on/off switch.

Features

- Dynamic super-cardioid microphone for speech and vocals
- Extended high-frequency response
- Consistent sound quality at varying distances or when off axis
- High sound pressure handling capability
- Optional silent on/off switch
- Shock-mounted capsule provides excellent suppression of handling noise
- Excellent feedback rejection
- Humbucking coil
- Rugged metal body

Package contents

- 1 e 845 / e 845 S microphone
- 1 MZQ 800 microphone clamp
- 1 pouch
- 1 instruction manual

Product overview A*

- 1 Sound inlet basket
- 2 XLR-3 connector
- 3 On/off switch (e 845 S only)
- 4 Screw (e 845 S only)

* Diagrams can be found on the cover pages.

Using the microphone

Switching the e 845 S on/off

- ▶ Use the on/off switch to switch the the e 845 S on or off.
- ▶ If necessary, use the screw ④ to lock the on/off switch ③ in the "on" position.

Positioning the microphone C

Pos.	Resulting sound	Commentary
C.1	<ul style="list-style-type: none">• High proximity effect (large bass boost)• Powerful, direct sound	Very little crosstalk from other sound sources
C.2	<ul style="list-style-type: none">• Less proximity effect (less bass boost)• Some room ambience, natural, balanced sound	More crosstalk from other sound sources
C.3	<ul style="list-style-type: none">• Very little proximity effect (minimal bass boost)• More room ambience, indirect sound	Higher crosstalk from other sound sources

If sibilance occurs:

- ▶ Position the microphone slightly to the side and not directly in front of the mouth.

Positioning the monitor loudspeakers B

- ▶ To prevent feedback and crosstalk, position your monitor loudspeakers in the angle area of the highest cancellation of the microphone (approx. 120°).

Cleaning and maintaining the e 845

Caution Liquids can damage the electronics of the product!

Liquids entering the housing of the product can cause a short-circuit and damage the electronics.

- ▶ Keep all liquids away from the product.
- ▶ Do not use any solvents or cleansing agents.

- ▶ Unscrew the sound inlet basket ①.
- ▶ Remove the foam insert from the sound inlet basket ①.
- ▶ Use a slightly damp cloth to clean the sound inlet basket ① from the inside and outside.
- ▶ Reinsert the foam insert into the sound inlet basket ① and replace the sound inlet basket on the microphone and screw it tight.

Specifications

Transducer principle	dynamic
Frequency response	40 ... 16,000 Hz
Pick-up pattern	super-cardioid
Sensitivity (free field, no load at 1 kHz)	1.8 mV/Pa
Nominal impedance (at 1 kHz)	approx. 350 Ω
Min. terminating impedance	1 kΩ
Connector	XLR-3
Temperature range	0°C to +40°C
Dimensions	∅ 46 x L 185 mm
Weight	330 g

The polar diagram and the frequency response curve D can be found on the cover pages.

Connector assignment

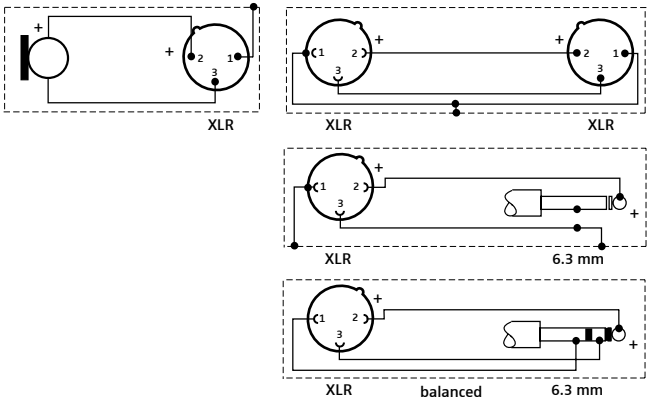

Manufacturer Declarations

Warranty

Sennheiser electronic GmbH & Co. KG gives a warranty of 24 months on this product.

For the current warranty conditions, please visit our website at www.sennheiser.com or contact your Sennheiser partner.

FOR AUSTRALIA ONLY

Sennheiser goods come with guarantees that cannot be excluded under the Australian Consumer Law. You are entitled to a replacement or refund for a major failure and compensation for any other reasonably foreseeable loss or damage. You are also entitled to have the goods repaired or replaced if the goods fail to be of acceptable quality and the failure does not amount to a major failure.

This warranty is in addition to other rights or remedies under law. Nothing in this warranty excludes, limits or modifies any liability of Sennheiser which is imposed by law, or limits or modifies any remedy available to the consumer which is granted by law.

To make a claim under this warranty, contact Sennheiser Australia Pty Ltd, Unit 3, 31 Gibbes Street Chatswood NSW 2067, AUSTRALIA.

Phone: (02) 9910 6700, email: service@sennheiser.com.au.

All expenses of claiming the warranty will be borne by the person making the claim.

The Sennheiser International Warranty is provided by Sennheiser Australia Pty Ltd (ABN 68 165 388 312), Unit 3, 31 Gibbes Street Chatswood NSW 2067 Australia.

In compliance with the following requirements



















- WEEE Directive (2012/19/EU)

Please dispose of this product at the end of its operational lifetime by taking it to your local collection point or recycling center for such equipment.

CE Declaration of Conformity

- RoHS Directive (2011/65/EU)
- EMC Directive (2004/108/EC)

The declaration is available at www.sennheiser.com.

	e 602-II	e 604	e 608	e 609 silver	e 614	e 835	e 845	e 865
						•	•	•
						•	•	•
					•		•	
					•			
	•	•	•					
					•			
	•				•			
				•				
	•							
	•							
					•			
	•							
		•	•	•				
		•	•	•				
	•	•		•				
		•	•	•	•			
					•			
	•	•				•		
			•	•	•		•	•

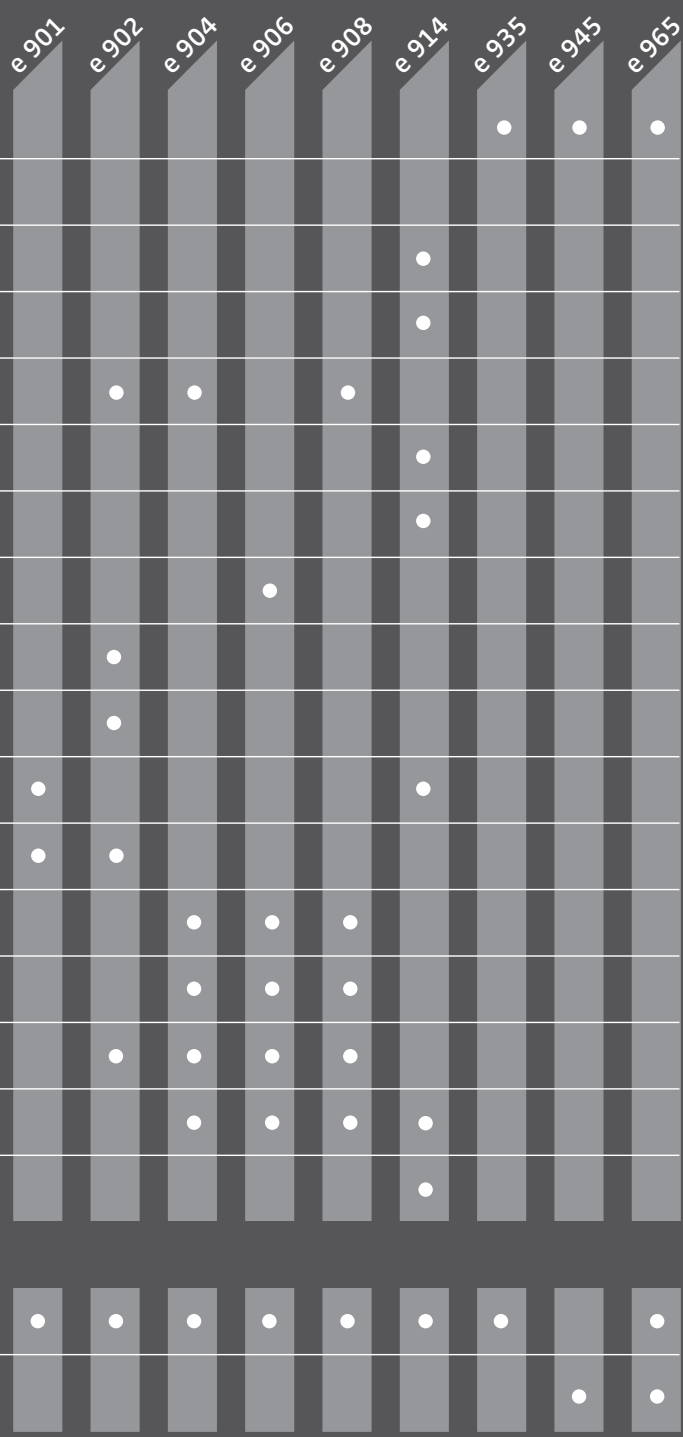



Sennheiser electronic GmbH & Co. KG

Am Labor 1, 30900 Wedemark, Germany
www.sennheiser.com

Publ. 08/15, 511656/A02